

DCS 900 Digital Control System

Installation
Operation
Maintenance
Instruction



READ ALL WARNINGS CAREFULLY
BEFORE INSTALLING

Table of Contents

1.	INTRODUCTION.....	4
1.1	PRINCIPLE OF OPERATION.....	4
1.2	MANUFACTURER'S PRODUCT WARRANTY	4
1.3	EUROPEAN TECHNICAL FILE LOCATION	4
1.4	UNPACKING THE CONTROLLER	5
2.	INSTALLATION AND WIRING	6
2.1	SELECTING LOCATION.....	6
2.2	MOUNTING	6
2.3	WIRING	7
2.4	COOLING TOWER INSTALLATION.....	7
2.4.1	FLOW ASSEMBLY.....	8
3.	CONTROLS	10
3.1	KEY PAD DEFINITIONS	10
4.	OPERATION	12
4.1	POWER UP (INITIALIZATION)	12
4.2	CONTROLLER SETUP	12
4.2.1	K - FACTOR SETUP	14
4.3	CONDUCTIVITY SENSOR CALIBRATION.....	15
4.4	PROGRAMMING THE CONTROLLER.....	17
4.4.1	SETPOINT (SET).....	17
4.4.2	DIFFERENTIAL (DIFF).....	17
4.4.3	TIMER	18
4.4.4	LIMIT	18
4.5	OPERATING MODES	22
4.5.1	OFF (STANDBY)	22
4.5.2	CONDUCTIVITY MONITOR	22
4.5.3	FORCED-ON	26
4.6	LOSS OF POWER	27
4.7	FACTORY INITIALIZATION.....	27
5.	SPECIFICATIONS	28
6.	MAINTENANCE	29
6.1.1	SENSOR REMOVAL/REPLACEMENT	29
6.1.2	CLEANING THE SENSOR	30
7.	TROUBLESHOOTING	31
7.1	ERROR CODES.....	32
7.2	DIAGNOSTICS.....	33
8.	WIRING & CONNECTION DRAWINGS	34
8.1	CONDUIT CONNECTIONS	34
8.2	FLOW SWITCH AND WATER METER CONNECTIONS	35
8.3	CHANGING CELL CONSTANT	36

Conventions:

The following conventions are used in this document.



A WARNING DEFINES A CONDITION THAT COULD CAUSE DAMAGE TO BOTH THE EQUIPMENT AND THE PERSONNEL OPERATING IT. PAY CLOSE ATTENTION TO ANY WARNING.



Notes are general information meant to make operating the equipment easier.



Tips have been included within this bulletin to help you run the equipment in the most efficient manner possible. These "Tips" are drawn from the knowledge and experience of our staff engineers, and input from the field.



This is a procedure heading. A Procedure Heading indicates the starting point for a procedure within a specific section of this manual.

The following standards have been developed to make using this manual easier. Formatting certain sections of text so that they stand out from the main body alerts the reader that there is some item of interest within a specific paragraph by drawing attention to:

- Text that has been formatted ***bold and italicized*** (e.g., ***Figure 2-C***) indicates reference text.
- Text that has been formatted in UPPER CASE letters, and surrounded by brackets [] indicates a button to be pressed (e.g., [TIMER]).
- Text that has been formatted in **Title Case** letters, using the **Arial - Bold** Font indicates a mode selection (e.g., **Forced On**).

1. INTRODUCTION

These installation, operation and maintenance instructions cover your controller. Refer to the controller nameplate to determine the actual model.

1.1 Principle of Operation

The controller is designed to control conductivity and feed inhibitor in an open-air cooling tower. It measures the conductivity of the re-circulating water and activates a 'bleed' relay output (typically attached to a solenoid activated blow down valve) when it exceeds a set point value. A second relay (typically attached to a chemical metering pump) is activated to feed inhibitor into the tower.

The Inhibitor feed relay can be programmed to activate with one of four timer types:

- Limit – The feed relay activates with the bleed up to a programmable limit time.
- Pulse – The controller receives pulses from an external source (either dry contact or open collector) and activates the bleed relay for a programmable time period.
- Percent – The bleed relay activates for a percentage of a programmable time period.
- Percent Post – The bleed relay activates for a percentage of the bleed time up to a limit time value.

1.2 Manufacturer's Product Warranty

The manufacturer warrants its equipment to be free of defects in material or workmanship. Liability under this policy extends for eighteen (18) months from the date of purchase or one (1) year from the date of installation, whichever comes first. The electronic components will be covered under this policy for a period which extends for twenty four (24) months from the date of purchase. The manufacturer's liability is limited to repair or replacement of any device or part which is returned, prepaid, to the factory and which is proven defective upon examination. This warranty does not include installation or repair cost and in no event shall the manufacturer's liability exceed its selling price of such part.

The manufacturer disclaims all liability for damage to its products through improper installation, maintenance, use or attempts to operate such products beyond their functional capacity, intentionally or otherwise, or any unauthorized repair. The manufacturer is not responsible for consequential or other damages, injuries, or expense incurred through the use of its products.

The above warranty is in lieu of any other warranty, either expressed or implied. The manufacturer makes no warranty of fitness of merchantability. No agent of ours is authorized to make any warranty other than the above.

The European Union Warranty address is listed below, however, please note that the seller should be contacted first.

Pulsafeeder Europe
Marssteden 68
7547 AD. Enschede

1.3 European Technical File Location

P.O. Box 91
Washington
NE37 1YH
United Kingdom

1.4 Unpacking the Controller

Check all equipment for completeness against the order and for any evidence of shipping damage. Shortages and damages should be reported immediately to the carrier and to the manufacturer.

The carton should contain the following:

1. Controller
2. Instruction Manual
3. Flow switch with Tee
4. Conductivity Sensor (with Tee if no flow assembly)
5. Accessory pack which includes IOM and a flow switch key used to disable the flow switch option in the event that this feature is not used or malfunctions.

Options:

- 1) Mounted flow assembly. If this option was ordered the controller will come mounted onto a polyethylene back plate along with a flow assembly. The flow assembly will include the flow switch and sensor tee.
- 2) Carbon graphite sensor.

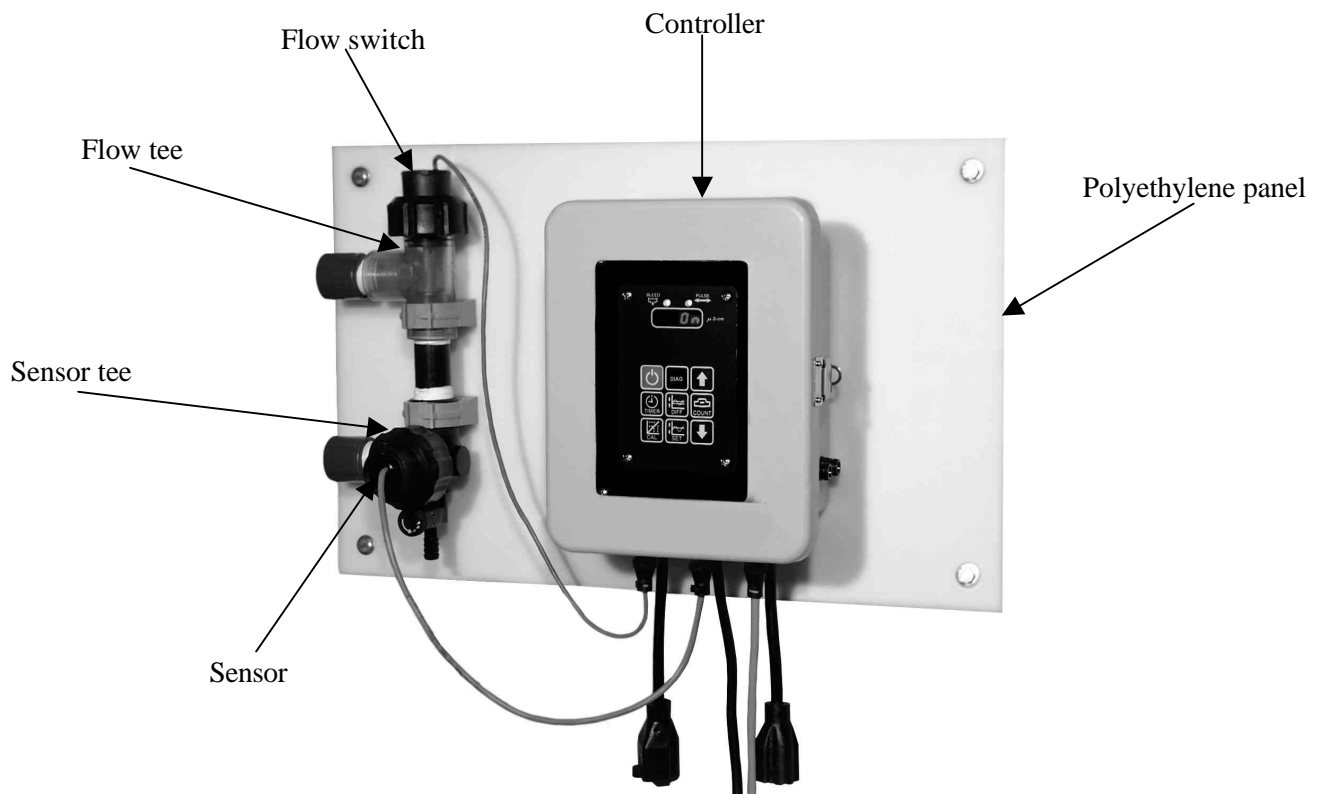

Before you get started it is recommended that you condition your conductivity sensor to the system water by soaking the sensor for at least two hours. If you do not condition your sensor, expect to recalibrate your system within 24 hours.

2. Installation and Wiring

The controller should be located in an area that allows convenient connections to both the chemical metering pump as well as the bleed valve. The controller housing is rated NEMA 4X and can be installed outdoors in a protected area. Avoid continuous temperatures in excess of 40°C (104°F), direct sunlight and rain. To do otherwise could result in damage or malfunction.

2.1 Selecting Location

Select a mounting location convenient to grounded electrical and plumbing connections. Mount the controller on a wall or other vertical surface with adequate lighting. Position so operator has access to the unit and a clear view of front panel display.

2.2 Mounting

Refer to the mounting diagram below for dimensional data on where to drill the holes for mounting.

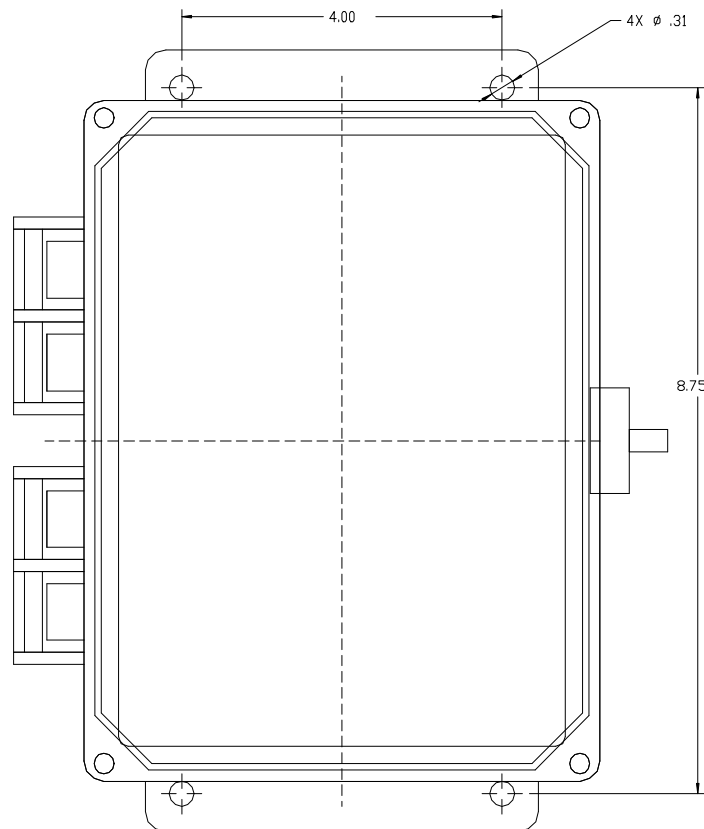

Mounting template for controller box

2.3 Wiring

1. The controller should be wired to an electrical source that conforms to those on the controller nameplate. (Applying higher voltage than the controller is rated for will damage the internal circuit.)



RISK OF ELECTRICAL SHOCK. THIS PRODUCT IS SUPPLIED WITH A THREE-PRONG GROUNDING TYPE POWER PLUG. TO REDUCE RISK OF ELECTRICAL SHOCK, CONNECT ONLY TO A PROPERLY GROUNDED, GROUNDING TYPE RECEPTACLE.

2. In the electronic circuit of the control unit, protection from surge voltage is made by means of surge absorbing elements and high voltage semiconductors. Nevertheless, excessive surge voltage may cause failure in some areas. Therefore the controller should never share a branch circuit that supports heavy electrical equipment (e.g. large motors). The use of a surge suppression device in line with the controller is strongly recommended! The device should meet or exceed the following minimum requirements:

Response:	<1nS
Energy Dissipation:	400 Joules
Protection:	L-N, L-G, N-G

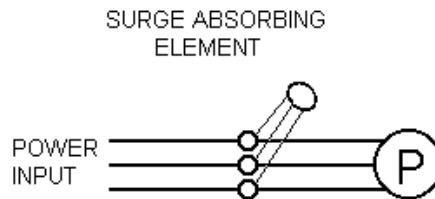
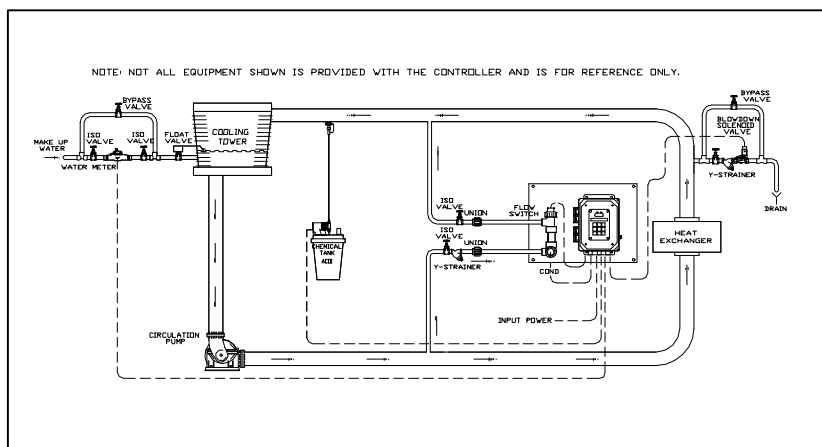

Figure 5

2.4 Cooling Tower Installation

The diagram below depicts a typical cooling tower system and where the sensor, flow switch and bleed valve should be. Make sure that all fittings and connections are secure. Plumbing of the conductivity electrode, flow switch and water meter is critical to the successful operation. Installation should comply with all national state and local codes.



2.4.1 Flow Assembly

A sample line with between 1 to 5GPM (4 to 19LPM) of flow is required for installation of the Flow Switch and Conductivity Sensor. It is a good idea to install isolation valves and unions around these items to allow easy service. An up-stream strainer should be installed to block debris that could foul the sensor. If the pump is to inject directly into this line (not recommended), always use a back check valve to prevent chemical backup around the sensors.

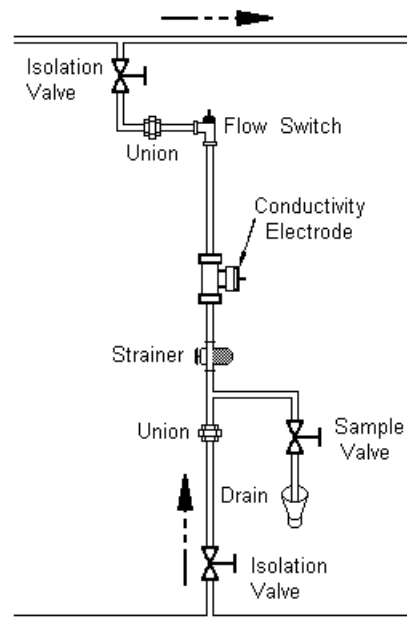

Figure 7

2.4.1.1 Flow Switch

The Flow Switch accessory consists of a clear body, a red flow poppet and a sensing cap. Flow causes the poppet to rise activating a switch in the sensing cap.

Install the Flow Switch in the sample stream piping so that the cap is at the top and the flow poppet is vertical. Flow should enter the bottom and exit the top to the right or left. There must be at least 1 GPM (3.81 LPM) of flow across the switch for it to activate properly. It is also advisable to check the line to assure that siphoning will not occur (holding the flow switch).

The Flow Switch to controller cable length should not exceed 60ft (18m).

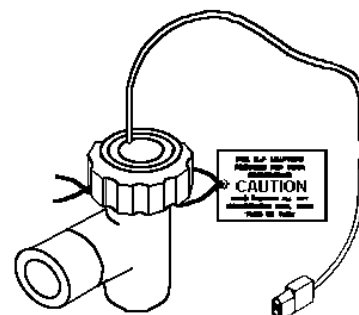

NOTE

The flow switch can be disabled by using the flow-switch key included in the accessory pack. To use the key, un-plug the flow switch cable from the controller and plug in the key into the flow switch DIN connection.

2.4.1.2 Conductivity Sensor

Install the Conductivity Sensor in the sample line using the supplied tee or elbow. Install sensor upstream of any chemical injection points (use a check valve to prevent back flow). The tee or elbow should be installed with the sensor surfaces below the water level. The Tee should be installed in a vertical run of pipe, or if installed in a horizontal run, the tee with the sensor in it should point either horizontally or straight down.

The elbow should be installed so flow enters horizontally at the left leg of the elbow and exits vertically to the flow switch.

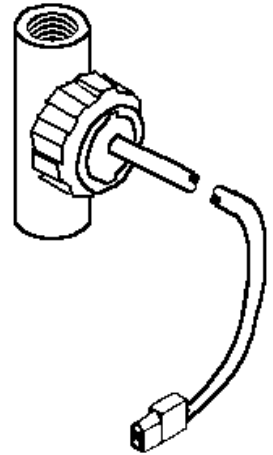

If installed incorrectly, the sensor will trap air around its sensing surfaces. Make sure the sensor body is below the water level in the line. Carbon graphite sensors should have their slot oriented in the direction of flow.

The Sensor to controller cable length should not exceed 35ft (16.5m).

2.4.1.3 Water Meter (Accessory)

Install the Water Meter in the makeup line in accordance with the manufacture’s instructions. The controller can receive input from one of two types of water meters – dry contact or open collector (aka hall effect). To operate properly with the controller the water meter must generate a dry contact switch closure or open collector switch (sinking) proportion to the flow. The open collector input provides a +5 volt DC input to the water meter through a 510 ohm resistor.

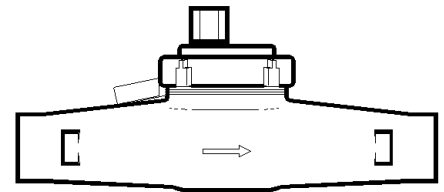

Refer to the *Wiring and Connections* section for Water Meter wiring details

A dry contact water meter generates a pulse based on a specific volume of water dependent on the rating of the meter (e.g. 1 pulse = 100 gallons). The open collector water meter generates a pulse rate that can be related back to a flow rate. The way the open collector meter works is through a paddle wheel that is inserted into the flow stream. Pulses are generated through the spinning of the paddle wheel inserted into the flow. In order to relate the pulse rate to an actual volume of flow, the controller must know the size and type of pipe that the water meter is inserted into. This ratio is determined by a number called the K-factor and is specific to the meter manufacturer. Refer to the *Operation* section for details on configuring the “K” factor. .

3. Controls

This Controller uses a microprocessor to control its operation. All adjustments and changes to operation are made through the 8-key touch-pad (refer to *Figure 8*). The controller displays operating information through numeric and status LED's.

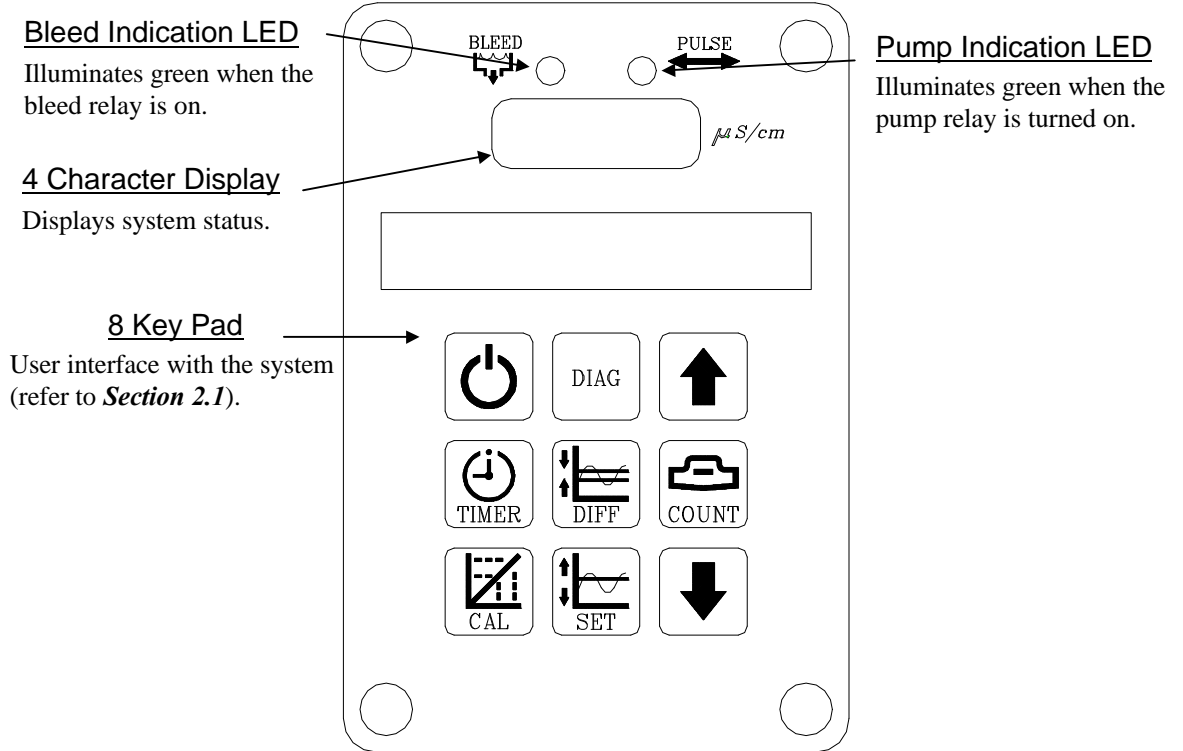





Figure 8

3.1 Key Pad Definitions

- 
ON/Standby Activates/Deactivates Automatic Control (Control Mode) – display reflects current reading. Forces pump relay on. Forces pump relay off.
- 
UP/DOWN Used in conjunction with a function key to increase [UP] or decrease [DOWN] the displayed value by a fixed amount.
- 
SET Sets the conductivity setpoint in $\mu\text{S}/\text{cm}$.
 Range = 0 – 6000 $\mu\text{S}/\text{cm}$
 10 $\mu\text{S}/\text{cm}$ per single [UP] / [DOWN] key press.
 100 $\mu\text{S}/\text{cm}$ auto increment when key is held.
- 
DIFF Sets the differential value used to determine the Bleed relay shut-off point.
 Range = 0 – 6000 $\mu\text{S}/\text{cm}$
 10 $\mu\text{S}/\text{cm}$ per single [UP] / [DOWN] key press.
 100 $\mu\text{S}/\text{cm}$ auto increment when key is held.



CAL

Sets the reading of the installed conductivity sensor to a known value.
Range = 0 – 6000 μ S/cm
10 μ S/cm per single [UP] / [DOWN] key press.
100 μ S/cm auto increment when key is held.



TIMER

Dependant on timer setup:

Limit Timer

Sets the pump relay 'on' limit time in HH:MM format.
Range = 00:00 to 23:59
0:01 per single [UP] / [DOWN] key press.
1:00 auto increment when key is held.

Water Meter Timer ((DCS 902 only)

Sets the pump relay 'run time' in MM:SS format.
Range = 00:00 to 59:59
0:01 per single [UP] / [DOWN] key press.
1:00 auto increment when key is held.

Percent Post Timer

Sets the pump relay 'limit time' in MM:SS format.
Range = 00:00 to 59:59
0:01 per single [UP] / [DOWN] key press.
1:00 auto increment when key is held.

Percent Timer

Sets the percent time base in MM:SS format
Range = 00:00 to 59:59
0:01 per single [UP] / [DOWN] key press.
1:00 auto increment when key is held.



COUNT

Dependant on timer setup:

Limit Timer

No function (display will blank).

Water Meter Timer ((DCS902 only)

Sets the number of water meter counts (or gallons or liters if the "K" factor is set).
Range = 1 to 9999
1 count per single [UP] / [DOWN] key press.
10 count auto increment when key is held.

Percent Post Timer

Sets the percent of Bleed Time to operate the pump.
Range = 0 to 100%
1% per single [UP] / [DOWN] key press.
10% auto increment when key is held.

Percent Timer

Sets the percent on time.
Range = 0 to 100%
1% per single [UP] / [DOWN] key press.
10% auto increment when key is held.



DIAG

Diagnostics key. Troubleshooting tool used to validate operation of specific functions in the unit.

4. Operation

This section describes initialization and operation of the DCS 900.

4.1 Power Up (Initialization)



BEFORE APPLYING POWER, INSURE THAT THE DEVICES BEING CONTROLLED ARE NOT IN A POSITION TO CAUSE HARM OR DAMAGE IF ACTIVATED UPON INITIAL STARTUP.

1. With the Controller installed and connected to the Cooling Tower as discussed in the previous section, apply power.
2. When power is applied, the following occurs:
 - All of the display elements are illuminated for 1 second.
 - The configuration number is displayed for 1 second.
 - The software revision number is displayed as "r X X r" for 1 second.
 - The timer is reset.

This sequence is displayed as follows:

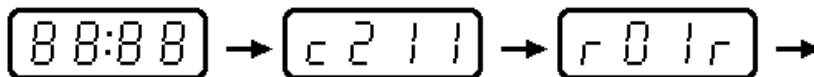

3. The controller then determines its last mode of operation (i.e., **Off** (Standby), **Conductivity Monitor**, **Forced On** or **Forced On Run**). Then, based on the mode, it will display:

- OFF (for **Off** (Standby)),
- ON (for **Forced On**), or
- Current conductivity reading (e.g., 2540 for **Conductivity Monitor**), or

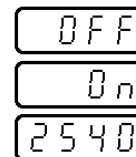

4.2 Controller Setup

A configuration string is used to define the operation of the controller. The value entered in this string selects:

1. Timer type
2. Setpoint type
3. Water meter type (DCS902 only)

The configuration string is displayed whenever power is applied to the controller.

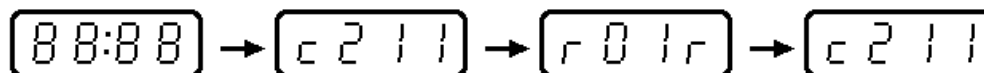

In the example above, the configuration string is "211". Each digit in this string is significant.



Refer to *Section 8 – Wiring & Connection Drawings* for additional information on wiring the water meter inputs.

CONFIGURATION STRING												
		C										
TIMER TYPE	<table border="1"> <thead> <tr> <th>TIMER</th> <th>VALUE</th> </tr> </thead> <tbody> <tr> <td>1 = LIMIT</td> <td>HH:MM N/A</td> </tr> <tr> <td>2 = PULSE *</td> <td>MM:SS 1 - 9999</td> </tr> <tr> <td>3 = PERCENT POST</td> <td>MM:SS 0 - 100%</td> </tr> <tr> <td>4 = PERCENT</td> <td>MM:SS 0 - 100%</td> </tr> </tbody> </table>	TIMER	VALUE	1 = LIMIT	HH:MM N/A	2 = PULSE *	MM:SS 1 - 9999	3 = PERCENT POST	MM:SS 0 - 100%	4 = PERCENT	MM:SS 0 - 100%	-
TIMER	VALUE											
1 = LIMIT	HH:MM N/A											
2 = PULSE *	MM:SS 1 - 9999											
3 = PERCENT POST	MM:SS 0 - 100%											
4 = PERCENT	MM:SS 0 - 100%											
SETPOINT	<table border="1"> <tbody> <tr> <td>1 = RISING</td> </tr> <tr> <td>2 = FALLING</td> </tr> </tbody> </table>	1 = RISING	2 = FALLING	-								
1 = RISING												
2 = FALLING												
WATER METER *	<table border="1"> <tbody> <tr> <td>1 = CONTACTING</td> </tr> <tr> <td>2 = OPEN COLLECTOR (TURBINE)</td> </tr> </tbody> </table>	1 = CONTACTING	2 = OPEN COLLECTOR (TURBINE)	-								
1 = CONTACTING												
2 = OPEN COLLECTOR (TURBINE)												
* The Water Meter input must be present for this option (Series CW only).												

Example: c212 is a Pulse Timer with a rising setpoint that accepts an open collector (Turbine) water meter input.

Note: Factory Default = C111



If you are unfamiliar with the settings described here, completely read section 3 then return here.



Follow this procedure to reconfigure the software.

1. Remove power from the controller (by unplugging it) for a minimum of 5 seconds.
2. With the controller unplugged, press and hold [SET] and plug the controller back in.
3. Continue to hold [SET]. The controller will go through the normal power-up sequence:
 - All of the display elements are illuminated for 1 second.
 - The configuration number (e.g., c211) is displayed for 1 second.
 - The software revision number is displayed as "r X X r" for 1 second.

This sequence is displayed as follows:

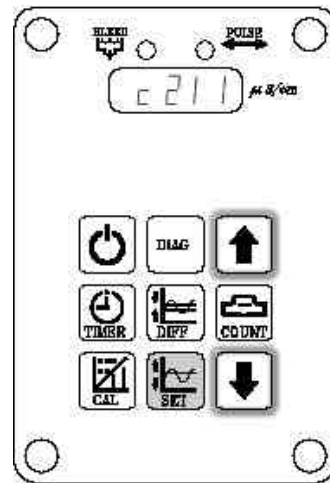
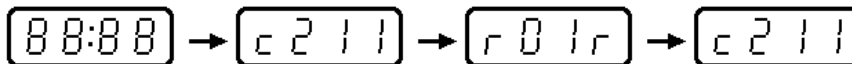

4. Continue to hold [SET]. The display will show the configuration value (e.g., 'c211') constantly.
5. Continue to hold [SET]. Press [UP] to increase the configuration value (e.g., 'c211' to 'c212'). Press [DOWN] to lower the displayed value (e.g., 'c211' to 'c122').
6. Upon releasing [SET] the new configuration is stored and the controller resets.
7. Observe the power-up sequence and verify that the configuration value (e.g., 'c211') appears as set in step 5.



Calibration is not affected by reconfiguration (i.e., you do not have to re-calibrate).



Timer values are re-set to factory defaults with reconfiguration. Re-check all settings after reconfiguration.

NOTE

4.2.1 K - Factor Setup

If the controller will be set up to operate with an open collector paddle wheel type (Hall Effect) water meter, the K-Factor will need to be set for proper operation. Refer to the documentation supplied with your water meter to determine the correct K-factor value. Configure the controller for the Hall Effect water meter by setting the configuration string to c212 or c222 . Refer to the previous section for instructions on how to set the controller to the correct configuration string.



The K-Factor translates the pulses generated by the flow meter into gallons or liters (depending on your setting). When you configure the Pulse Timer value setting you are specifying the number of pulses per gallon, or liter. For example, if your Water Meter has a “K” factor of 991 (on the gallons scale) it will generate 991 pulses for every gallon of fluid that flows past it. In this case you would set the “K” factor value to 991. You would then set the %/value setting in gallons.



Follow this procedure to set the K-Factor:

1. Remove power from the controller (by unplugging it) for a minimum of 5 seconds.
2. With the controller unplugged, press and hold [COUNT] and plug the controller back in.
3. Continue to hold [COUNT]. The controller will go through the normal power-up sequence:
 - All of the display elements are illuminated for 1 second.
 - The configuration number (e.g., c211) is displayed for 1 second.
 - The software revision number is displayed as "r X X r" for 1 second.

This sequence is displayed as follows:

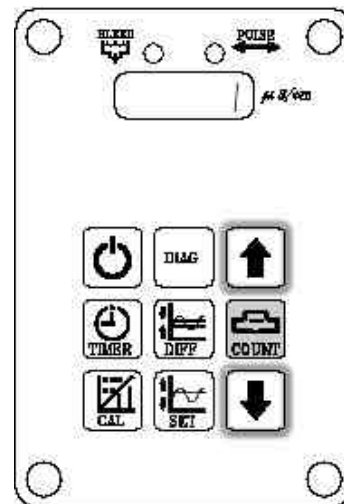
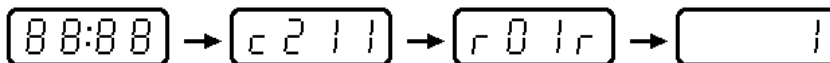

4. Continue to hold [COUNT]. The display will show the K-Factor value (e.g., '1') constantly.
5. Continue to hold [COUNT]. Press [UP] to increase the K-Factor value by 100 (e.g., 101 to 201 to 301, etc.). Press [DOWN] to lower the value by 1 (e.g., 9999 to 9998, etc.).
6. Upon releasing [COUNT] the new configuration is stored and the controller resets.

4.3 Conductivity Sensor Calibration

A 2-point calibration is performed on the controller prior to shipment. Additional calibration will depend on the desired accuracy. The conductivity sensor must be calibrated to your system during the initial power up phase, and any time the sensor is cleaned or replaced. To calibrate the conductivity sensor, perform the following procedure:



TIP

Before you get started it is recommended that you condition your conductivity sensor to the system water by soaking the sensor for at least two hours. If you do not condition your sensor, expect to recalibrate your system within 24 hours.

Tools required – Hand Held Conductivity meter

1. Close the isolation valves located before and after the conductivity sensor (refer to *Figure 6*).
2. Open the Sample Valve, and drain the line.
3. Close the Sample Valve.



Zero Calibration

The zero calibration removes any offset present in the electronics. In most cases the zero calibration performed at the factory will be sufficient for the life of the controller.



NOTE

A zero calibration should not be performed on carbon graphite sensors. These sensors show some conductance even when dry which prevents an accurate zero.

1. Remove the conductivity sensor from the system.
 - a) Flush the sensor with tap water and dry it off. Then hold the sensor in the air.
– or –
 - b) Flush the sensor and then install it in a flow tee or elbow filled with distilled water.



NOTE

Do not touch the electrodes. Oil from your skin can effect the sensor's ability to read conductivity correctly. If you calibrate your zero point using a water sample, the Conductivity Sensor must be installed in a flow tee or elbow. If necessary, obtain a cal-tee from your representative.



TIP

Distilled water is used in the factory for the zero calibration point.

2. Calibrate the zero or 'nil' point, by pressing [ON/STANDBY] to place the controller in the **Conductivity Monitor** mode.
3. Wait a minimum of 60 seconds for the sensor to stabilize to the sample (even if both are at room temperature).
4. Press and hold [CAL].

The display reads as shown below for 10 seconds while the conductivity is determined.



If the conductivity is less than 100µS/cm, the display is changed to nil.



If the conductivity is greater than 100, the actual value is displayed. Press [DOWN] to adjust the value to 0.

5. Release [CAL] and the Zero value is stored.
6. Install the sensor in the system.



System Calibration

System Calibration lets the controller display and control a value that is meaningful to you and conforms to some standard (like your hand held meter).

1. Verify the Sample Valve is closed.



The conductivity sensor must be installed in a flow tee or elbow to obtain a proper reading. We recommend using system water for the system calibration point. If you must calibrate using standard solutions, obtain a Cal-Tee from your representative.

2. Slowly open the Isolation Valves.
3. Wait a minimum of 60 seconds for the sensor to stabilize to the sample (even if both are at room temperature).
4. Open the Sample Valve and fill the sample cup of the hand held conductivity meter.
5. Close the Sample Valve.
6. Test and record the conductivity reading.

System conductivity must be greater than 100 $\mu\text{S}/\text{cm}$ for the calibration to be valid.

7. Press and hold [CAL].

The display reads as shown below until system conductivity is determined.

- [CAL]

If the solution is greater than 100 $\mu\text{S}/\text{cm}$, the value is displayed (e.g., 2540).

2540

8. Press either [UP] or [DOWN] to adjust the displayed value to the value determined in step 6 (e.g., in the example above press [UP] to change 2540 to 2550).
9. Release [CAL] and the tested calibration point is stored.
10. Check the system conductivity with the hand held conductivity meter again. If the result does not match the last value entered, repeat this procedure.

4.4 Programming the Controller

Now that you have completed the Sensor Calibration, you are ready to program the controller.

4.4.1 Setpoint (SET)

A Setpoint is a setting at which the controller activates an output – such as a solenoid valve and/or a bleed valve. The type of setpoint – **Rising/HIGH** or **Falling/LOW** defines which side of the setpoint the relay and solenoid activates. A **Rising/HIGH** setpoint activates when the input goes above the setpoint and is commonly used in conductivity control (where you want to keep the conductivity under a certain value). A **Falling/LOW** setpoint activates the output when the value goes below the setpoint.



The setpoint type can be set using the controller configuration string. Refer to Section 4.2 for further information. Factory Default = Rising/HIGH.

The factory default setpoint is 1500 $\mu\text{S}/\text{CM}$.



Follow this procedure to configure your setpoint.

1. Press and hold [SET] to view the current setpoint.
The factory default is 1500 $\mu\text{S}/\text{cm}$.
2. While holding [SET], press [UP] to increase the setpoint value. Press [DOWN] to lower the displayed value.
3. Upon releasing [SET] the new setpoint is stored and takes effect immediately.



Should you make a change to the setpoint while the controller is in the Forced On or Forced On-Run mode, the new setpoint will not take effect until you are in the Conductivity Monitor mode.

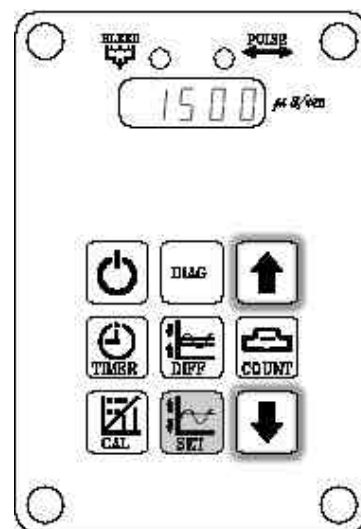

4.4.2 Differential (DIFF)

The Differential (DIFF) is also referred to as dead band or hysteresis. The differential is the offset applied to a setpoint to prevent chattering of the Bleed Relay around the setpoint. For example, if the setpoint is set to 1500 and the differential is set to 50, the Bleed Relay will turn on at 1500 and turn off at 1450. The factory default Differential value is 50 $\mu\text{S}/\text{CM}$.



Follow this procedure to configure the differential.

1. Press and hold [DIFF] to view the current differential setting.
The factory default is 50 $\mu\text{S}/\text{cm}$.
2. While holding [DIFF], press [UP] to increase the differential value. Press [DOWN] to lower the value.
3. Upon releasing [DIFF] the new differential is stored and takes effect immediately.



Should you make a change to the differential while the controller is in the Forced On or Forced On-Run mode, the new setpoint will not take effect until you are in the Conductivity Monitor mode.

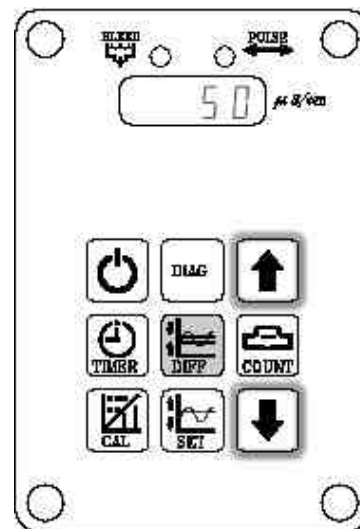

4.4.3 Timer

The controller configuration string allows the selection of one of four timer types:

- Limit
- Pulse
- Percent Post
- Percent

Refer to *Section 4.2* for further information on selecting a timer type. Factory Default = Limit Timer

4.4.4 Limit

When the timer is configured as a limit timer the pump relay is turned on with the bleed relay. If the continuous on time exceeds the limit time setting, the pump relay will be turned off so that chemical feeding will stop stroking while the bleed continues.

The Limit Timer is used to limit the length of time that the pump will inject a chemical. It is possible for a system upset (e.g. clogged blowdown strainer) to prevent the control of conductivity. Pumping chemical under these circumstances is counter-productive. Having the ability to set a time limit prevents the over feed of chemicals in these situations. The timer value is displayed in an hours and minutes format (HH:MM).

To setup this timer one parameter is required:



Time The maximum amount of time to continuously meter chemicals.
Range = 00:00 to 23:59 – (HH:MM)
Default: 01:30

Example: Timer is set to 00:15. Conductivity rises above the setpoint and the blowdown relay activates. Simultaneously the pump relay turns on, powering the metering pump. The bleed will continue until conductivity drops below the set point plus or minus the differential, but the pump relay will be turned off – stopping the metering pump, for a maximum time limit of 15 (00:15) minutes.



A time value always has the colon character ‘:’ displayed.



Follow this procedure to configure your timer.

1. Press and hold [TIMER] to view the current setting in an hour/minute format.
2. While holding [TIMER], press and release [UP] to increase the Limit Time value by one minute. Press [DOWN] and release to lower the displayed value. You can also press and hold [UP] or [DOWN] to automatically scroll the hours value.
3. Upon releasing [TIMER] the new value is stored in long term memory and takes effect immediately.



Should you make a change to the Timer while the controller is in the Forced On or Forced On-Run mode, the new duration will not take effect until you are in the Conductivity Monitor mode.

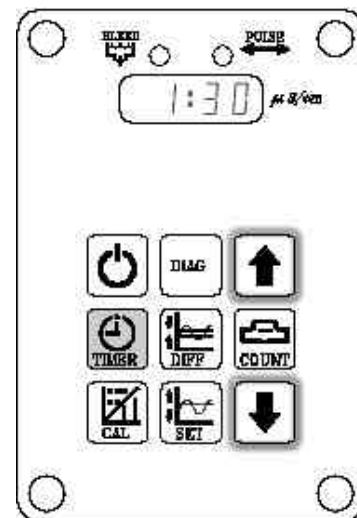

If the timer value is set to 00:00 the pump relay will operate without any limit.

4.4.4.1 Pulse (DCS 902 only)

The pulse timer is typically used in conjunction with a contacting head (or open collector turbine style) water meter to add a chemical in proportion to the added water. The value setting specifies the number of water meter pulses (or gallons or liters if a “K” factor is set) to accumulate before turning on the pump relay the length of time specified in the timer setting.

To setup this timer, two parameters are required:



Count The value setting represents the number of pulses (or gallons/liters if a “K” factor is set) to count before activating the metering pump.
Range = 1 to 9999
Default: 1



Time The amount of time to turn on the metering pump in minutes and seconds.
Range = 00:00 to 59:59 – (MM:SS)
Default: 01:30

Example: The Count (Value) is set to 15 and the run time (Timer) is set to 02:00. When the controller receives the 15th pulse the pump relay will turn on and remain on for 2 minutes (02:00). The controller will continue to accumulate pulses from the water meter during this time.



Refer to *Section 4.2 – Controller Setup* and *Section 4.2.1 K-Factor Setup* for additional information on configuring the “K” factor. Refer to *Section 8 – Wiring & Connection Drawings* for additional information on wiring the water meter inputs.



A time value always has the colon character ‘:’ displayed.



Follow this procedure to configure your timer.

1. Press and hold [COUNT] to view the pulse count value. This is the number of pulses (or gallons/liters if the “K” factor is set) to accumulate before turning on the pump relay.
2. While holding [COUNT], press and release [UP] or [DOWN] to adjust the value by 1. You can also press and hold [UP] or [DOWN] to automatically increment the value by 10.
3. Release [COUNT]. The setting is stored in long term memory and takes effect immediately.
4. Press and hold [TIMER] to view the run time in minute/second format.
5. While holding [TIMER], press and release [UP] or [DOWN] to adjust the value by 1 second. You can also press and hold [UP] or [DOWN] to automatically increment the value by 1 minute (01:00).
6. Release [TIMER]. The setting is stored in long term memory and takes effect immediately.

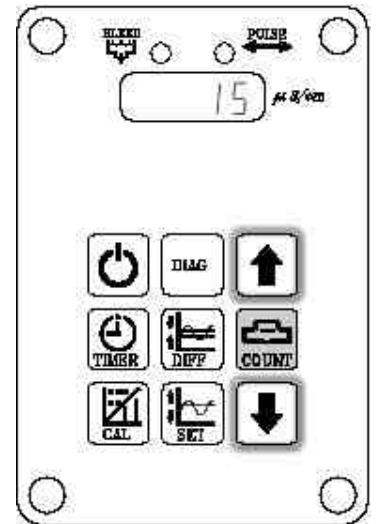

The pulse accumulator is cleared whenever the count (value) is satisfied. The controller will only accumulate pulses up to the count (value) setting.

4.4.4.2 Percent Post

The Percent Post timer feeds for a proportion of the bleed time up to a limit value after the bleed cycle completes.

It is used to feed chemical in proportion to the bleed time with the advantage of maximum chemical retention.

To set up this timer, two parameters are required:



Count The percent of the bleed time the metering pump should operate.
Range = 1 to 100%
Default: 100



Time The maximum run time in minutes and seconds.
Range = 00:00 to 59:59 – (MM:SS)
Default: 01:30

Example: Value is set to 50 (50% of Bleed time) and Timer is set to 02:00 (will not operate for more than 2 minutes). If conductivity rises above the setpoint and the bleed relay activates for 8 minutes. When bleed stops the pump relay will turn on and operate the metering pump for 02:00 (maximum run time setting is 2:00).



A time value always has the colon character ‘:’ displayed.



Follow this procedure to configure your timer.

1. Press and hold [COUNT] to view the percent bleed time value.
2. While holding [COUNT], press and release [UP] or [DOWN] to adjust the value by 1%. You can also press and hold [UP] or [DOWN] to automatically increment the value by 10%.
3. Release [COUNT]. The setting is stored in long term memory and takes effect immediately.
4. Press and hold [TIMER] to view the limit time in minute/second format.
5. While holding [TIMER], press and release [UP] or [DOWN] to adjust the value by 1 second. You can also press and hold [UP] or [DOWN] to automatically increment the value by 1 minute (01:00).
6. Release [TIMER]. The setting is stored in long term memory and takes effect immediately.

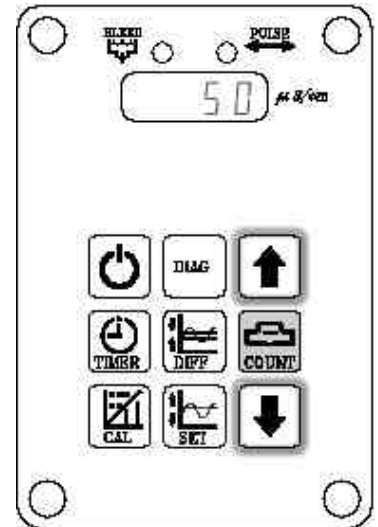

Should you make a change to the Timer while the controller is in the Forced On or Forced On-Run mode, the new duration will not take effect until you are in the Conductivity Monitor mode.



If the timer value is set to 00:00 the pump relay will not turn on.

4.4.4.3 Percent

The Percent timer feeds for a percentage of a time period. The cycle repeats indefinitely. It is used to continuously feed a chemical.

To set up this timer, two parameters are required:



Count The percent of the time cycle the metering pump should operate.
Range = 1 to 100%
Default: 100



Time The length of the time cycle in minutes and seconds.
Range = 00:00 to 59:59 – (MM:SS)
Default: 01:30

Example: Value is set to 50 and Timer is set to 02:00. The pump relay will activate to run the metering pump for 1 minute (50% of 02:00 = 01:00) then wait for 1 minute. The cycle repeats.



A time value always has the colon character ‘:’ displayed.



Follow this procedure to configure your timer.

1. Press and hold [COUNT] to view the percent value.
2. While holding [COUNT], press and release [UP] or [DOWN] to adjust the value by 1%. You can also press and hold [UP] or [DOWN] to automatically increment the value by 10%.
3. Release [COUNT]. The setting is stored in long term memory and takes effect immediately.
4. Press and hold [TIMER] to view the time cycle in minute/second format.
5. While holding [TIMER], press and release [UP] or [DOWN] to adjust the value by 1 second (00:01). You can also press and hold [UP] or [DOWN] to automatically increment the value by 1 minute (01:00).
6. Release [TIMER]. The setting is stored in long term memory and takes effect immediately.

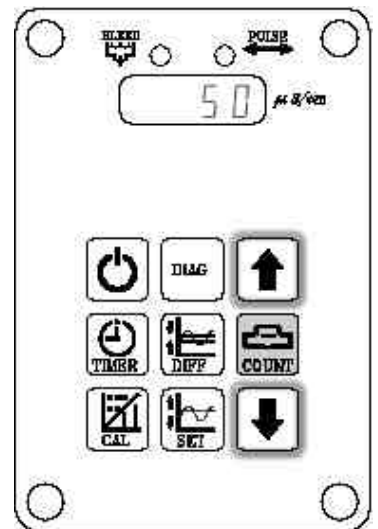

NOTE Should you make a change to the Timer while the controller is in the Forced On or Forced On-Run mode, the new duration will not take effect until you are in the Conductivity Monitor mode.



If the timer value is set to 00:00 the pump relay will not turn on.

4.5 Operating Modes

The controller has four operating modes:

- **Off** (Standby)
- **Conductivity Monitoring***
- **Forced On**
- **Forced On - Run**

* When the **Conductivity Monitoring** mode is active, there are four possible sub-modes:

- Bleed & Feed
- Feed
- Bleed
- No Flow

Each of the modes and sub-modes of operation will be covered in this section.

4.5.1 Off (Standby)

Off (Standby) represents the mode that the controller is in when pump relay is off and the bleed relay is disabled. To place the controller in the **Off (Standby)** mode press [ON/STANDBY].

To exit **Off (Standby)** to **Conductivity Monitor**, press [ON/STANDBY].



While it is the intent of the manufacturer to ship all controllers in the Off (Standby) mode, it is possible that the controller could be in an active mode causing one of the relays to be activated with AC power. Be sure that you take all safety precautions.

Press [ON/STANDBY] to activate this mode.

When the controller is in the **Off** (Standby) mode the following occurs:

1. The display reads 'OFF'
2. The pump relay is disabled (off).
3. The relay output is disabled.



Press [ON/STANDBY] to exit this mode.

4.5.2 Conductivity Monitor

Conductivity Monitor is the most common mode of operation. While in this mode the current conductivity reading (e.g., 2540) is displayed. The operation of the pump and Bleed Relays are controlled by previously defined parameters.

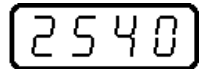

4.5.2.1 Bleed

Bleed starts when a conductivity reading is greater or less than or equal to the defined setpoint. It ends when the conductivity falls below the defined setpoint minus the Differential point (if your system is configured as a Rising Setpoint). The **Bleed** mode is a sub-mode of **Conductivity Monitoring**.

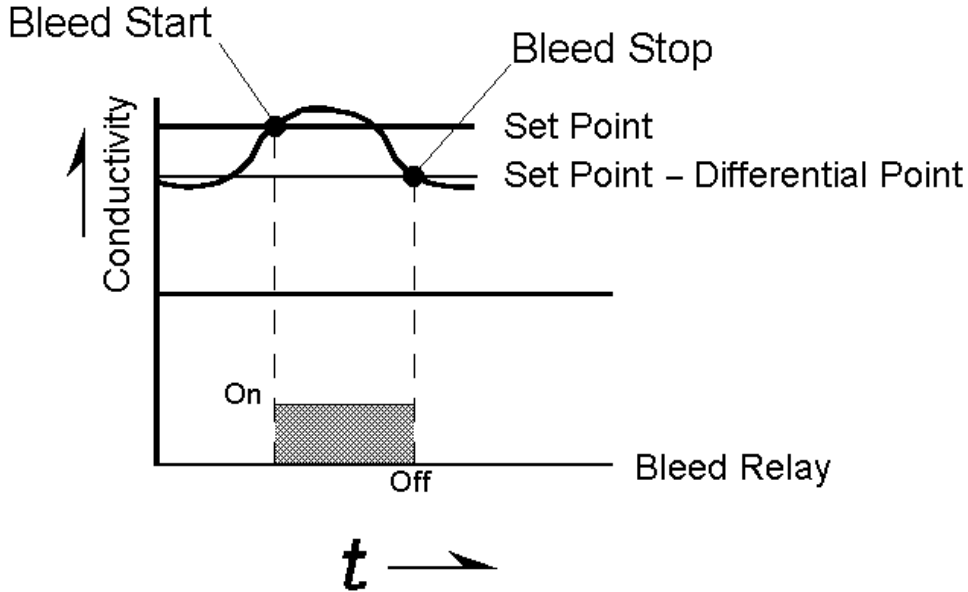

Referring to the diagram above, you will see that at **Bleed Start**, the Bleed Relay is energized.

Press [ON/STANDBY] to activate this mode.

While the controller is in the **Bleed** mode:

1. The display will alternate between the current reading (e.g., 2540) and the status (e.g. bLEd) every two seconds.



The controller remains in the **Bleed** mode until:

- a) A Timer activates causing the controller to enter the **Bleed & Feed** mode.
- b) The conductivity level drops below the setpoint minus the differential point. (As shown in the figure above.)
- c) [ON/STANDBY] is pressed.
- d) Power is cycled.

4.5.2.2 Bleed & Feed

Bleed & Feed starts when a conductivity reading is greater or less than or equal to the defined setpoint and the timer activates (e.g., the pulse count exceeds the setpoint). It ends when the conductivity falls below the defined setpoint minus the Differential point (if your system is configured as a Rising Setpoint) or the controller timer stops. The **Bleed & Feed** mode is a sub-mode of **Conductivity Monitoring**.

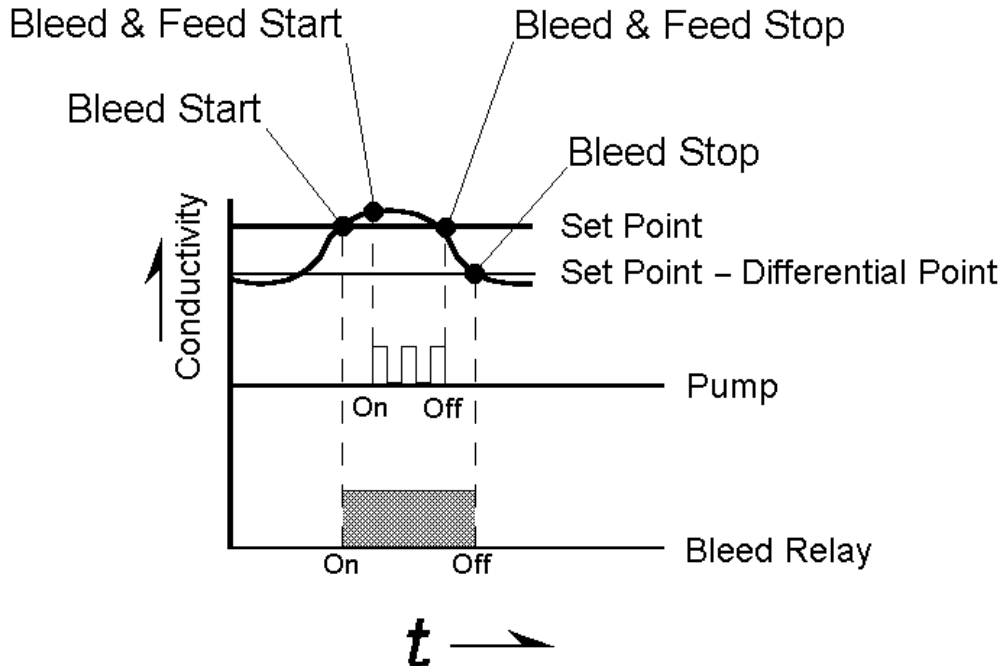

Press [ON/STANDBY] to activate this mode.

While the controller is in the **Bleed & Feed** mode:

1. The display will alternate between the status (e.g. bLEd), current reading (e.g., 2540), status (e.g., FEEd) and the accumulated run time (e.g., 00:03 in mm:ss format) every four seconds.

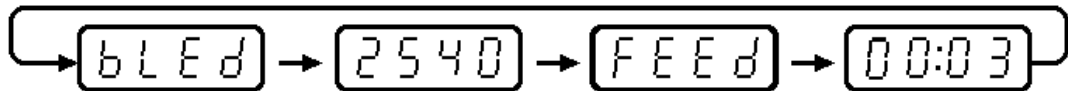

2. The count-up timer (run time) is incremented every second from the 00:00 start value.

The controller remains in the **Bleed & Feed** mode until:

- a) The conductivity level drops below the setpoint minus the differential point (as shown in the figure above).
- b) [ON/STANDBY] is pressed.
- c) Power is cycled.
- d) The controller Timer expires (e.g., the metering pump runs for the length of time set in the Timer).

4.5.2.3 Feed

The **Feed** mode is a sub-mode of **Conductivity Monitor**. It starts when the conductivity is below the setpoint and the timer activates.

Press [ON/STANDBY] to activate this mode.

While the controller is in the **Feed** mode: (metering pump relay is turned on)

The display will alternate between the conductivity reading (e.g., 2540), the phrase “FEEd” and the accumulated run time (e.g., 00:03 in MM:SS format) every three seconds.



The controller exits the **Feed** mode when one of the following occurs:

- The controller timer expires (e.g., the pump runs for the length of time set in the Timer).
- The conductivity level rises above the setpoint (causing the controller to enter the **Bleed & Feed** mode).
- [ON / STANDBY] is pressed.
- Power is cycled.



Upon exiting the **Feed** mode, the system returns to the **Conductivity Monitor** mode.

4.5.2.4 No Flow

When the Flow input detects “No Flow” (open circuit) the Pump and Bleed relays will not operate.



The flow switch can be disabled if necessary. To disable the flow switch, insert the flow-switch key that came in the accessory pack with the controller into the DIN connector for the flow switch on the controller.

When the controller is in the **No Flow** mode the following occurs:

- The display alternates (2 seconds) between the phrase 'No' and 'FLo'.
- The Bleed Relay output is set to the off state.
- The pump relay is set to the off state.

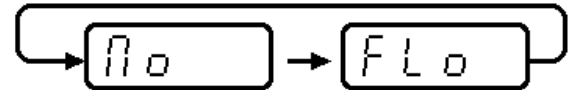

The controller will exit the **No Flow** mode when the flow input is restored. The **Forced On** and **Forced On Run** modes ignore the Flow input.

4.5.3 Forced-On

In the **Forced-On** mode the bleed relay and pump relay are activated for 5 minutes. It is useful for priming the pump after replacing the chemical supply.

Press and hold [ON/STANDBY] for more than 1 second but less than 5 seconds when in the **OFF** (Standby) mode to activate this mode.

When the controller is in the **Forced-On** mode:

1. The display reads 'On'.



The controller exits the **Forced-On** mode when one of the following occurs:

- a) The **Forced-On** mode is active for 5 minutes.
- b) [ON/STANDBY] is pressed



Upon exiting the **Forced-On** mode, the system is returned to the **Conductivity Monitoring** mode.

4.5.3.1 Forced-On Run

The **Forced-On Run** mode allows you to activate the pump relay with no time limit imposed. This mode is useful if you want the metering pump to operate without regard to conductivity.

Press and hold [ON/STANDBY] for more than 5 seconds when in the **OFF** (Standby) mode to activate this mode.

The controller exits the **Forced-On Run** mode when one of the following occurs:

- a) [ON/STANDBY] is pressed



Upon exiting the **Forced-On Run** mode, the system is returned to the **Off** mode.



The Controller Mode is stored in Long Term memory. In the event the controller loses power, when power is restored, the controller returns to the mode it was in at the time of the power loss.

4.6 Loss of Power

If power is lost while the controller is operating, when power is restored, the controller will return to the mode that was active at the time of the power loss. If the controller was operating in the **Forced-On** mode, when power is re-applied, the unit will enter the **Forced-On** mode and operate for a full five minutes (i.e., the timer is reset).

If a timer is active at power loss, it is re-set at power-up (i.e., it will not resume where it left off).

4.7 Factory Initialization

If [TIMER], [DIFF] and [COUNT] are pressed simultaneously, the controller performs a **Factory Initialization**. When the controller is in the **Factory Initialization** mode, the following occurs:

1. All factory defaults are moved from permanent memory (i.e., Flash), to long term memory (i.e., EEPROM).
2. The processor re-sets causing the program to re-execute power-up and the following sequence is displayed:

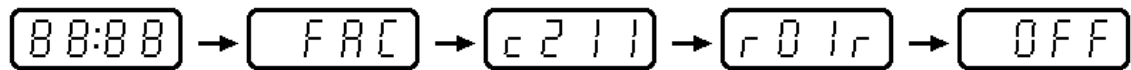

5. Specifications

All controllers will conform to the following specifications:

Unit Power:

- Operating voltage: 120 or 240 VAC +/- 10%, 5AMP's maximum.
- Protection, Fuse: 250VAC, 5A Slo-Blow removable.
- Cordage: 8' length 16AWG 3-Wire Domestic 120 VAC power cord set.

High Voltage Output (Bleed & Feed (Pump) Relays):

- Operating voltage: Same as supplied to unit.
- Capacity: 4AMP at 240VAC maximum.
- Protection: Fused
- Status: Normally Open.
- Cordage: 12" (min) Pigtail with Female Duplex Plug.

Analog Input (Conductivity):

- Sensor: 4-electrode cell with 10' cord length and 3/4" Tee (threaded).
- Sensor Connector: 8-pin DIN connector.
- Operating Range:
 - Conductivity: 0 – 6000 μ S/cm (Temperature Compensated). Unit will read 0-4000 μ S/cm at 100°C, 0 – 5000 μ S/cm at 75°C and 0-9999 μ S/cm at 25°C.
- Isolation: Isolated from Earth Ground only.

Flow Input:

- Input Type: Isolated Dry Contact only.
- Switching Technique: 5VDC supplied by controller.
- Sensor: Standard. Shorting jumper provided.
- Sensor Connector: 2-pin DIN connector.

Water Meter Input: (DCS 902 only)

- Input Type: Open collector (sinking) Isolated only
- Switching Technique: Open collector provided in device. 5VDC and ground provided by connection.
- Sensor: Standard with 10 ft cable.
- Sensor Connection: 8-pin DIN connector
- Minimum Closure: 125ms closed / 125ms open (Configuration String = cXX1)
2ms closed / 2ms open (Configuration String = cXX2)

User Interface:

- Display: 4 Character LED (Red Characters)
- Feed LED: Green LED. Illuminated when the pump relay is on.
- Bleed LED: Green LED. Illuminated when the bleed relay is on.
- Keypad: Membrane style, 9 Keys: On/Standby, Up, Down and 6 Function keys.

Enclosure:

- IP Rating: IP54 (Protected against dust and splashing water)
- NEMA Rating: Type 4X

Environment:

- Maximum Ambient Temperature: 104° F (40° C)

6. Maintenance



BEFORE PERFORMING ANY MAINTENANCE OR REPAIRS, BE SURE TO DISCONNECT ALL ELECTRICAL CONNECTIONS AND INSURE THAT ALL PRESSURE VALVES ARE SHUT OFF AND PRESSURE IN THE PUMP AND LINES HAS BEEN BLED OFF.



Always wear protective clothing, gloves and safety glasses when performing any maintenance or repairs on or around chemical metering pumps.

6.1.1 Sensor Removal/Replacement

In the event the Conductivity sensor requires replacement, perform the following.



Changing the sensor material (e.g., carbon graphite to stainless steel) requires a jumper setting change on the mother board (Cell Constant). Refer to section 8.3 Cell Constant jumper setting procedure and the Cell Constant selection diagram for further details.



Replacing a Sensor

1. Remove power from the controller.
2. Close the Isolation valves located before and after the Conductivity electrode (refer to *Figure 6*).
3. Open the Sample valve to drain the line and verify no flow through the line.
4. Once the line has drained, close the Sample valve.
5. Disconnect the electrical connection from the Conductivity electrode to the controller.
6. Remove the coupling nut from the sensor to be replaced. Remove the sensor by gently pulling straight down (refer to *Figure 9 – A*). The sensor is held in place by a rubber “O” ring.

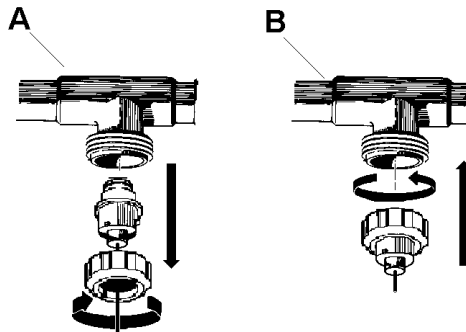

Figure 9

7. Gently install the new sensor into the tee. Verify that the sensor is firmly seated in the housing.



It may be necessary to rotate the sensor to align its “flat” with the mating feature on the Tee.

8. Slip the coupling nut over the electrical connector and then onto the housing threads and hand tighten the coupling nut (refer to *Figure 9 – B*).
9. Plug the sensor cable into the appropriate connection on the controller.
10. Verify the sample valve is closed.
11. Apply power to the controller

12. Open the Isolation valves that you closed in step 2.



Open the Isolation valves slowly to avoid water hammer.

6.1.2 Cleaning the sensor

By design, the 4-element conductivity electrode can overcome most forms of fouling. It is possible that in severe cases, periodic cleaning may be required.

6.1.2.1 Before you clean

Sensors can take up to 3 days to fully condition and stabilize to your system. If you experience conductivity drift during this period it is recommended that you recalibrate your sensor rather than blaming the drift on a fouled sensor and replacing it.

6.1.2.2 To clean the Stainless Steel conductivity sensor:

Some staining of the electrode surface is normal and will not effect sensor performance. To clean the electrodes try one of these techniques:

1. Wipe the sensors with a clean cloth.
2. Agitate the sensor in a solution of water and mild detergent. Rinse the sensor with tap water.
3. For stubborn stains, dip in a mild solution of muriatic acid then rinse with tap water.



USE PROPER HANDLING PROCEDURES INCLUDING RUBBER GLOVES, EYE PROTECTION AND PROTECTIVE CLOTHING, WHEN HANDLING ANY ACID SOLUTION.

Oils can affect sensor performance. Do not touch sensor surface. The sensor should be agitated in a mild solution of dish washing soap and water to remove oils transferred during handling.

IMPORTANT!: After cleaning, allow 3 days for the electrode surface to re-oxidize and the readings to fully stabilize.

6.1.2.3 To clean the Carbon Graphite sensor:

1. Immerse sensor in a solution of water and mild detergent.
When a stronger cleaning solution is required use concentrated hydrochloric acid mixed into 50% isopropanol.
2. Rinse the cell several times with distilled or deionized water.

IMPORTANT!: After cleaning, allow 3 days for the electrode surface to re-oxidize and the readings to fully stabilize.



USE PROPER HANDLING PROCEDURES INCLUDING RUBBER GLOVES, EYE PROTECTION AND PROTECTIVE CLOTHING, WHEN HANDLING ANY ACID SOLUTION.

7. Troubleshooting

Problem	Probable Cause	Remedy
Bleed LED Stays On.	Conductivity of water is above setpoint, Bleed restricted	Check Bleed line and do one of the following: <ul style="list-style-type: none"> • Clean strainer. • Clean solenoid. • Replace solenoid.
	Treatment chemicals or process liquid at sensor	Check sample stream injection of treatment chemicals/process liquid at sensor. Injection should be down stream.
	Conductivity of sample stream higher than system conductivity, sample stream restricted	Check for flow in sample stream and do one of the following: <ul style="list-style-type: none"> • Clean strainer. • Clean sample line.
Conductivity Reading Decreases while System Conductivity Increases.	Fouled sensor	Clean sensor.
Conductivity of System Stays Lower Than Setpoint, Never Or Rarely Bleeds.	Uncontrolled Bleed	Bleed valve leaking. Do one of the following: <ul style="list-style-type: none"> • Realign ball valve; if leaking by the ball valve. • Clean solenoid valve; if leaking by the solenoid valve. Close manual Bleed valve. Fix leaks in cooling system.
Conductivity Reading Drifts Lower than Sample Tested.	Sensor fouled	Clean sensor. Perform calibration. Follow stabilization time cautions. If decrease continues, necessitating frequent cleanings, try calibrating without cleaning. Slight coatings can be compensated for with re-calibration.
	Calibration procedure not carefully followed	
	Calibration point not near setpoint	Re-calibrate with solution near setpoint.
Front Panel Bleed LED Cycles On and Off.	Poor grounding of water sample	Tie flow assembly near sensor to earth ground.
	Air in sample line	Bleed air off. Close isolation valves. Loosen flow switch to bleed. Re-tighten before opening valves.
Controller Not Bleeding With High Conductivity	Differential (dead band) too tight	Widen differential. Check solenoid location (piping).
	No flow	Check flow switch and flow.
	Relay bad or fuse bad	Check relay and fuse.

Code	Definition	Cause	Description	Solution
E400	Drive Error	Fouled Sensor, Sensor Missing, Sensor Defect	This error is encountered when the controller attempts to boost its drive signal to overcome probe fouling but reaches its maximum value before the fouling is overcome.	Clean electrodes. Check all sensor connections. Cycle power. Replace Sensor.
E500	Temperature Compensation Error	Sensor Missing/Not connected. Bad Sensor connection. Sensor Defective.	The temperature sensor is generating a signal outside of the expected range.	Install sensor, check connections. Cycle power. Replace Sensor. Note: If the sensor is not connected, this will be the first error code generated.
E600	Zero Calibration Error	Sensor not in air or water with conductivity below 100µS/CM during calibration. or Attempting to zero calibrate a carbon graphite sensor.	This error occurs when you are attempting to perform a zero calibration but the average of the readings are not below 100µS/CM. A carbon graphite sensor will show some conductivity even when dry. This prevents an accurate zero.	Clean and dry off sensor. Check sensor connections. If using a wet sample, check sample. Cycle power. Replace sensor. Do not attempt to zero calibrate a carbon graphite sensor.
E700	Sensor Adjust Error	Fouled Sensor, Sensor Missing, Sensor Defect	This error occurs when the controller cannot adjust the probe drive signal to allow the probe feedback to fall into the designated window.	Clean electrodes. Check all sensor connections. Cycle power. Replace sensor.

If the problem cannot be corrected, it is possible to override the error code and operate the controller manually.



Manual Controller operation procedure:

1. While the error code displays (e.g. E500) press and release the [ON/STANDBY] key.
The controller will reset to the **Off** (Standby) mode.
2. Press and hold the [ON/STANDBY] key for 5 seconds. The controller will display the stroke rate percentage value (e.g. 100) and cycle at the set frequency. Refer to *Section 4.5.3 Forced-On Run* for further information.

7.2 Diagnostics

In most situations the troubleshooting guide and error codes supplied in this section is sufficient to identify problems and corrective action. In the event of an electronics failure, the diagnostics key may be used to verify specific functions of the controller electronics. This function is to be used in conjunction with trained technical support. Contact the factory if you suspect an electronics failure.

8. Wiring & Connection Drawings

8.1 Conduit Connections

8. Wiring & Connection Drawings

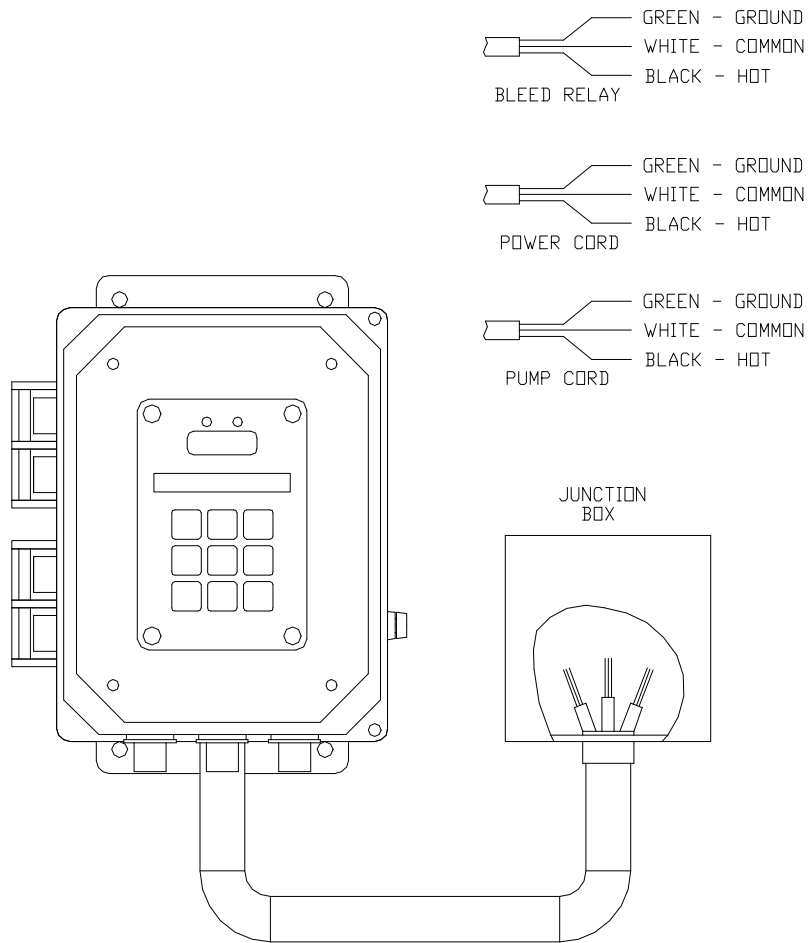

8.2 Flow Switch and Water Meter Connections

